

STONEGATE DESIGNS™

NEW Product Introductions
January 2011

CALL 1.269.429.8323

STONEGATE DESIGNS NEW PRODUCT JAN 2011

NEW Product Introductions

January 2011

Nectar Collection.....	4-7
Chelsea Collection.....	8-11
Candela Collection.....	12-14
Aston Collection.....	15-17
Cascade New Additions.....	19-20
Classique New Additions.....	21-22
Mesa New Additions.....	23-24
Finishing Touches - fabrics, finishes, woods.....	25-26

All designs in this brochure are copyrighted.
Fabric and finish may vary due to the uniqueness of each piece.



LC11092 - shown in 057 Hand-Rubbed Bronze and 317 Eggshell Silk Pongee.

THE NEW
**NECTAR
COLLECTION**

Create a buzz with
this retro inspired
honeycomb pattern.



*LP11089 - shown in 041 White Powder-Coat and 317 Eggshell Silk Pongee.
Top Right Image: LP11090 - shown in 057 Hand-Rubbed Bronze and 317 Eggshell Silk Pongee.*

THE NEW NECTAR COLLECTION

CHANDELIERS

PENDANTS

LC11092

- 3x75-Watt Type A
- Hardwire
- UL/CUL Approved

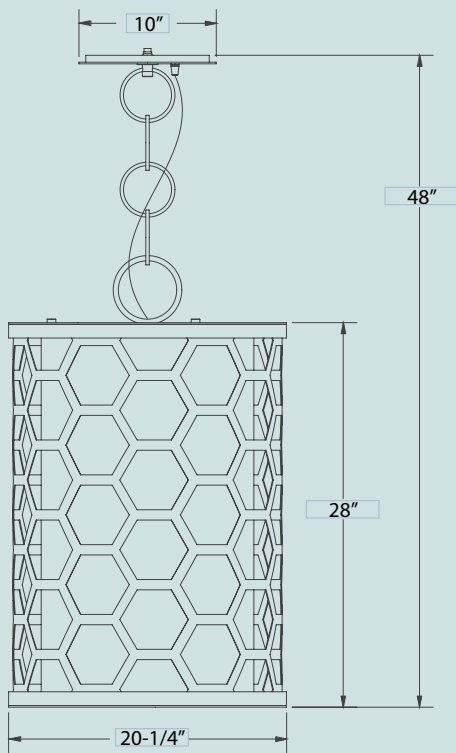

LC11093

- 3x75-Watt Type A
- Hardwire
- UL/CUL Approved

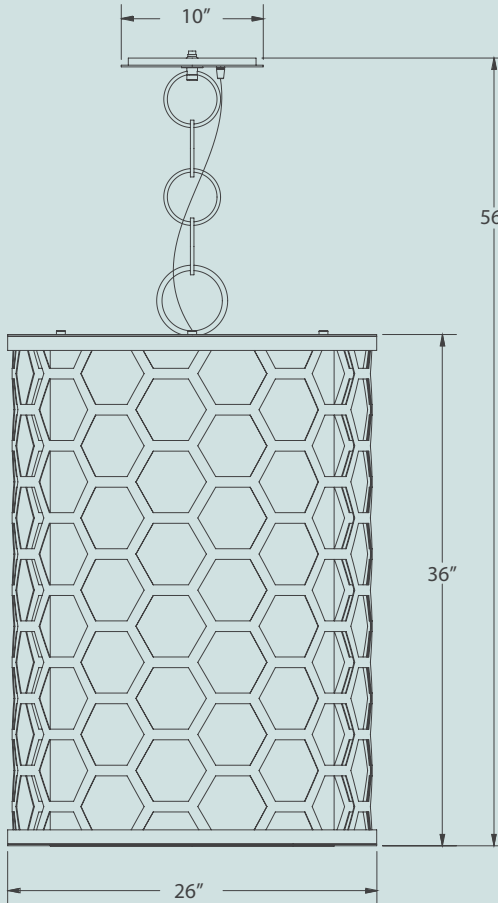

LP11089

- 1x100-Watt Type A
- Hardwire
- UL/CUL Approved

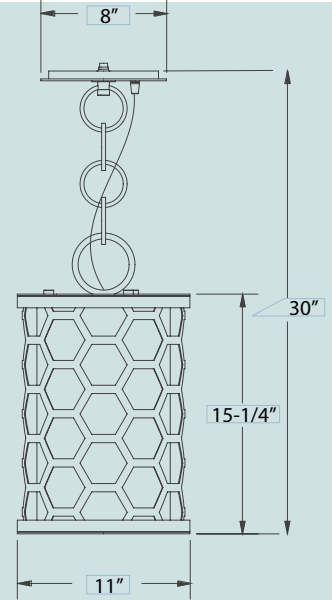

**Nectar Chandeliers and Pendants include 3-ft of custom chain.
Each link is approx. 4-inches. Chain is available up to 6-feet.
If you have a specific height requirement, please
inform customer service when placing your order.*

LP11090

- 1x100-Watt Type A
- Hardwire
- UL/CUL Approved

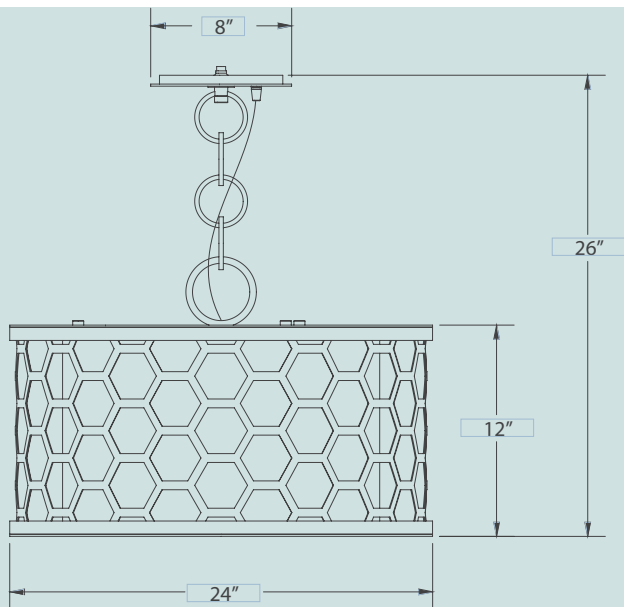

LP11091

- 1x100-Watt Type A
- Hardwire
- UL/CUL Approved

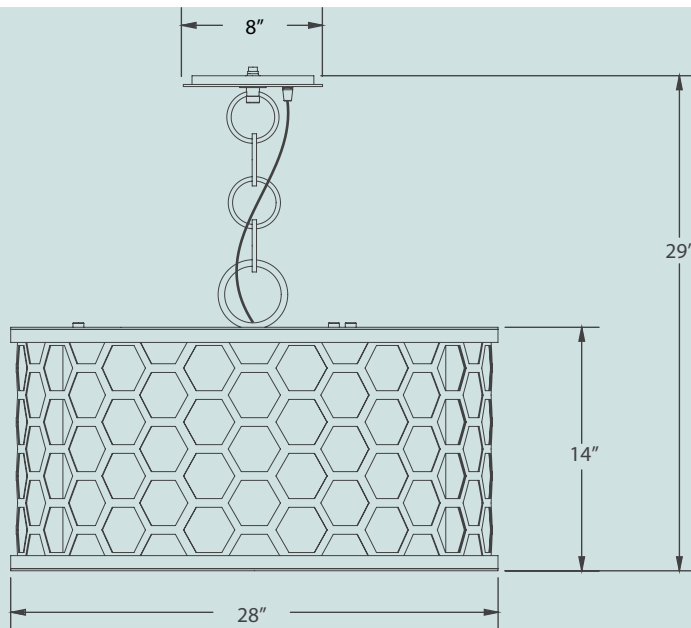

Available Finish: 041, 042, 055, 057.
 Available Fabric: 317, 614, 690.
 See finishing touches on pages 25-26.



LP11094 - shown lit in 057 Hand-Rubbed Bronze and 614 Ivory Silk Dupioni, with 4" glass finial.

THE NEW

CHELSEA COLLECTION

Unique metal work,
sculpted this way and that,
becomes art with light.



*LS11096 - shown in 057 Hand-Rubbed Bronze and 614 Ivory Silk Dupioni.
Top Right Image: LT11097 - shown in 057 Hand-Rubbed Bronze and 614 Ivory Silk Dupioni.*

CALL 1.269.429.8323

THE NEW CHELSEA COLLECTION

-----PENDANTS-----

LP11094

- 6x40-Watt Candelabra
- Hardwire
- UL/CUL Approved

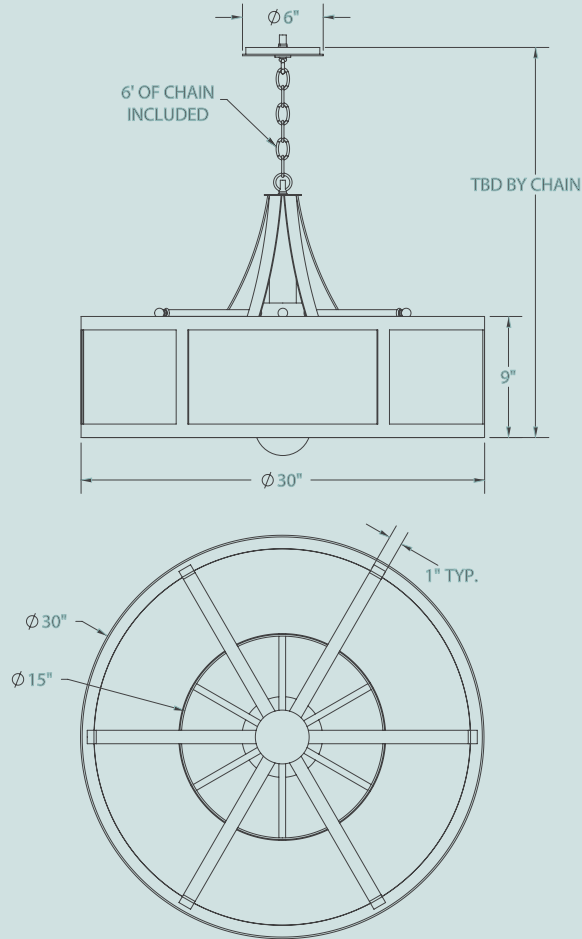

LP11095

- 6x40-Watt Candelabra
- Hardwire
- UL/CUL Approved

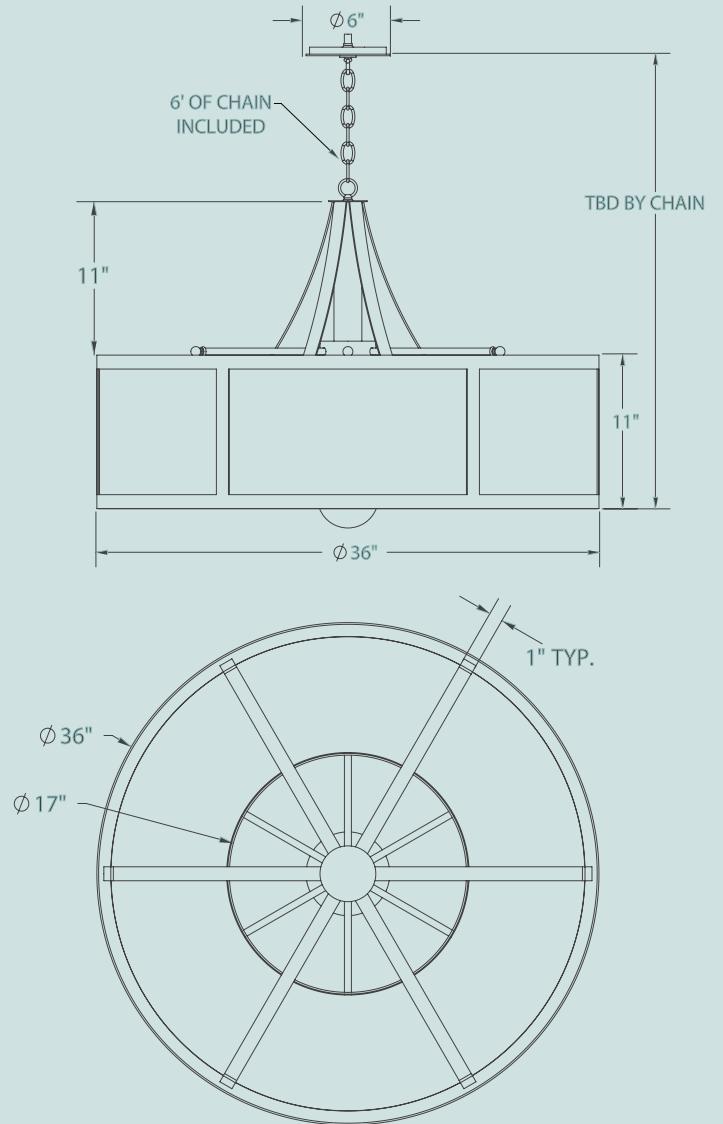

Available Finish: 055, 057.
 Available Fabric: 317, 614, 690.
 See finishing touches on pages 25-26.

|----SCONCES----|

LS11096

- 2x40-Watt Candelabra
- Hardwire
- UL/CUL Approved

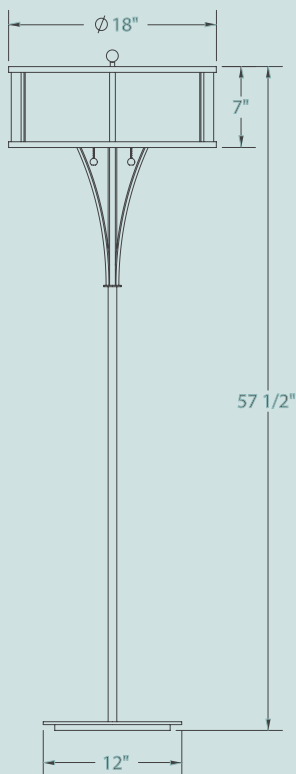
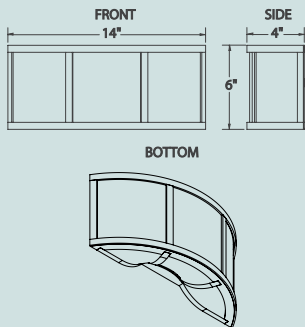

LF11098

- 2x75-Watt Type A
- Pull Chain
- UL/CUL Approved

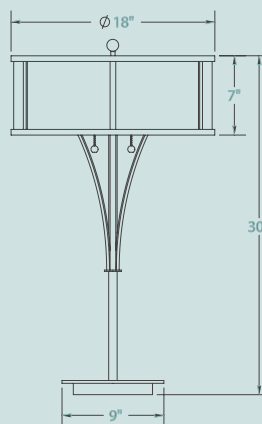

LT11097

- 2x75-Watt Type A
- Pull Chain
- UL/CUL Approved

|----FLOOR LAMPS----|

|----TABLE LAMPS----|



LP11123 - shown in W01 Ebony, P06 Brushed Nickel, and and 328 White Linen.

THE NEW
**CANDELA
COLLECTION**

This substantial piece
will become the focal
point of any setting.



LC11124 - shown lit in W03 Walnut, 057 Hand-Rubbed Bronze and 614 Ivory Silk Dupioni.

CALL 1.269.429.8323

THE NEW CANDELA COLLECTION

CHANDELIERS

LC11124

- 12x40-Watt Candelabra
- Hardwire
- UL/CUL Approved

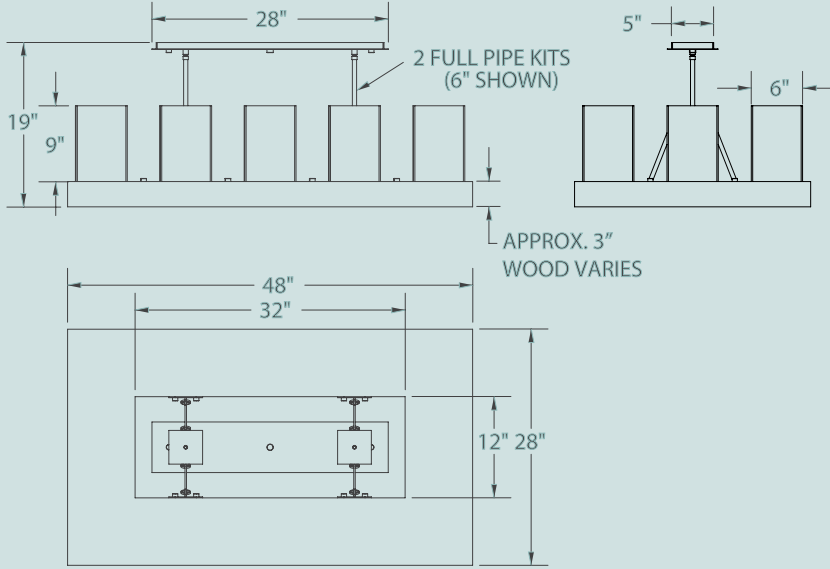

LC11125

- 8x40-Watt Candelabra
- Hardwire
- UL/CUL Approved

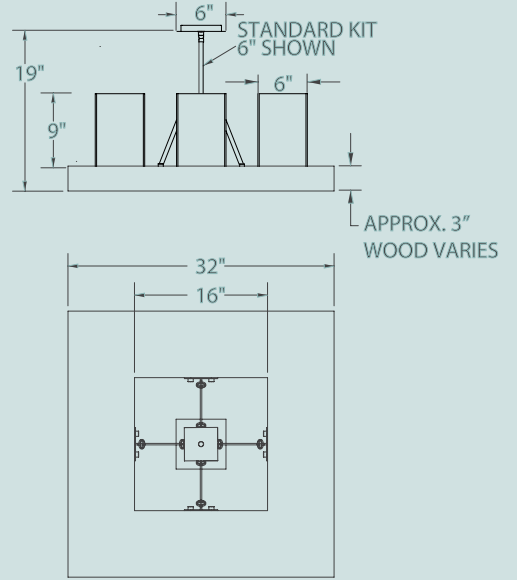

Available Finish: 041, 042, 057, P05, P06. Available Wood: W01, W03. Available Fabric: 317, 614, 690. See finishing touches on pages 25-26.

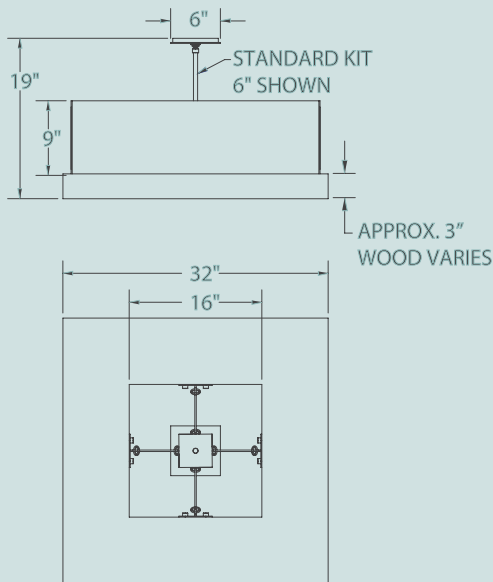

LP11123

- 8x40-Watt Candelabra
- Hardwire
- UL/CUL Approved

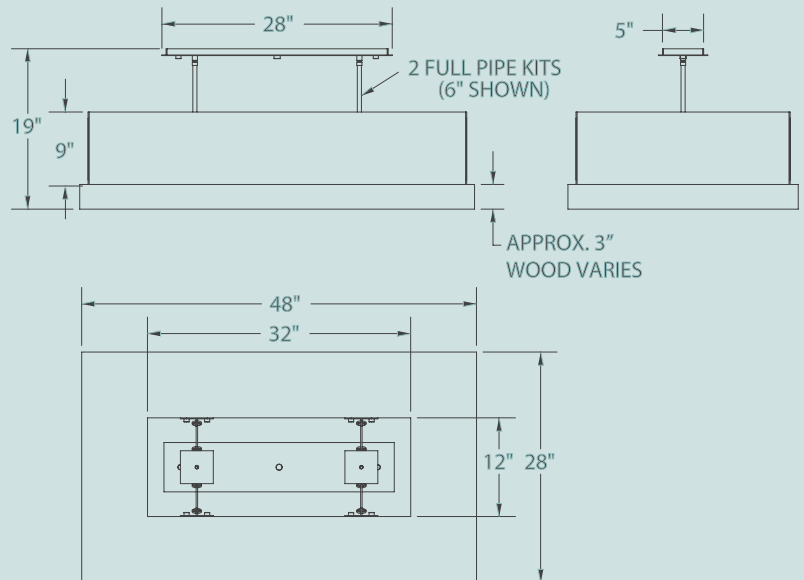

LP11126

- 12x40-Watt Candelabra
- Hardwire
- UL/CUL Approved

PENDANTS

THE NEW
**ASTON
COLLECTION**

Crisp and tailored,
with cufflink inspired accents,
for a sophisticated style.



LP11085 - shown lit in P05 Polished Nickel, 614 Pewter Silk Dupioni with 614 Black Silk Dupioni Trim.

THE NEW ASTON COLLECTION

|----PENDANTS-----

LP11081

- 2x75-Watt
- Hardwire
- UL/CUL Approved

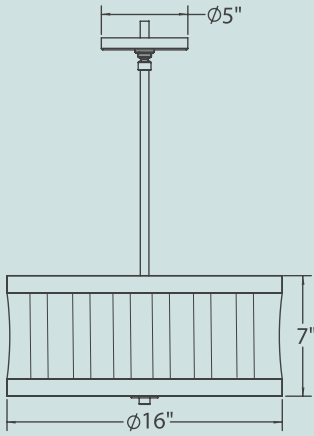

LP11082

- 2x75-Watt
- Hardwire
- UL/CUL Approved

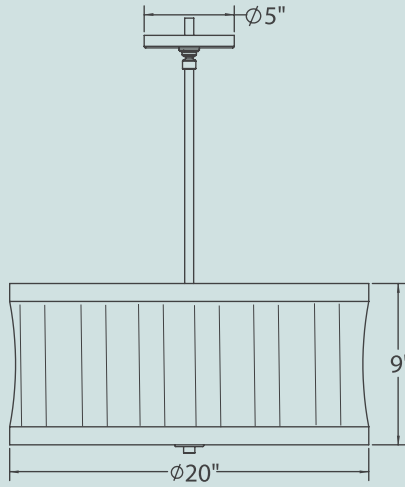

LP11083

- 3x75-Watt
- Hardwire
- UL/CUL Approved

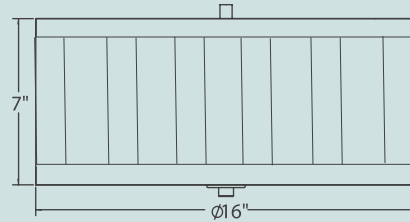
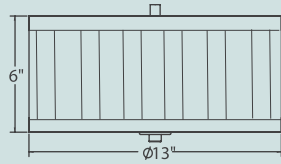
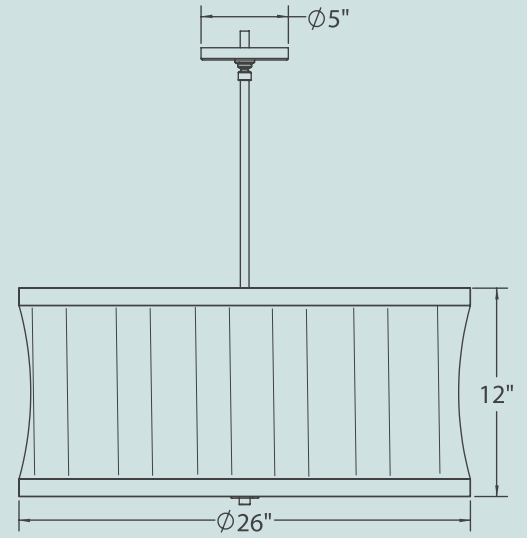

LP11087 Flush

- 1x75-Watt
- Hardwire
- UL/CUL Approved

LP11088 Flush

- 1x75-Watt
- Hardwire
- UL/CUL Approved

|----PENDANTS-----

LP11084 Semi-Flush

- 2x75-Watt
- Hardwire
- UL/CUL Approved

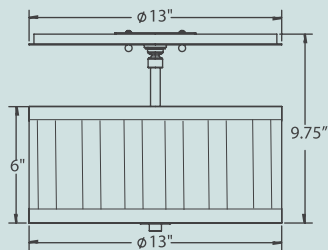

LP11085 Semi-Flush

- 2x75-Watt
- Hardwire
- UL/CUL Approved

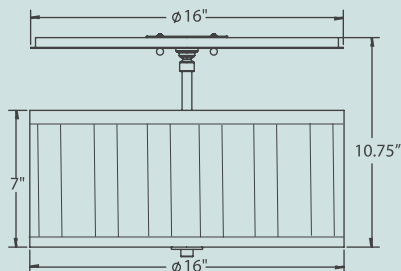

LP11086 Semi-Flush

- 3x75-Watt
- Hardwire
- UL/CUL Approved

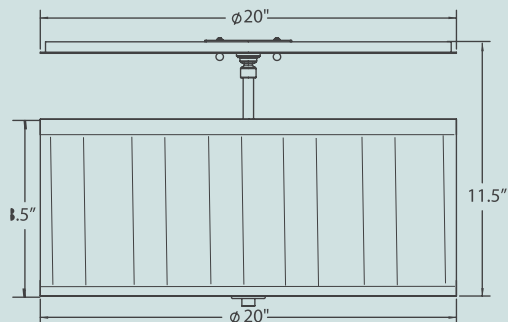

Available Finish: 057, P05, P06.

Available Body Fabric: 614. Available Trim Fabric: any.

See finishing touches on pages 25-26.

RELIGHTS

CASCADE COLLECTION

Our masterpiece
collection, designed
to impress.



LR11110 - shown in 614 Espresso Silk Dupioni with 614 Pewter Silk Dupioni.

THE CASCADE COLLECTION ADDITIONS

|----RELIGHTS-----|

LR11110

- Attaches to Recessed Lighting
- Without Diffuser
- Spring Hooks or Twist/Lock

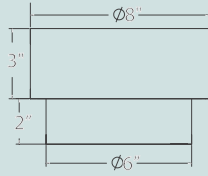

LR11113

- Attaches to Recessed Lighting
- Without Diffuser
- Spring Hooks or Twist/Lock

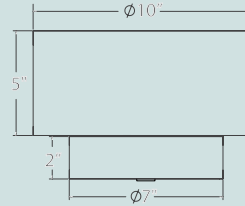

Available Fabric: 305, 313, 317, 328, 614, 690, 692, 749, 758.
See finishing touches on pages 25-26.

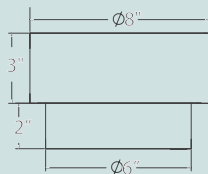

LR11145

- Attaches to Recessed Lighting
- White Acrylic Diffuser/White Finial
- Spring Hooks or Twist/Lock

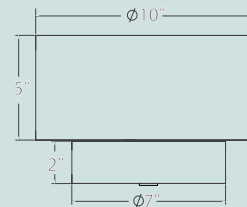

LR11147

- Attaches to Recessed Lighting
- White Acrylic Diffuser/White Finial
- Spring Hooks or Twist/Lock

NEW ADDITIONS TO THE
**CLASSIQUE
COLLECTION**

The most recognizable
and popular
classic collection.



LP11099 - shown in 328 Beige Linen.

THE CLASSIQUE COLLECTION ADDITIONS

|----PENDANTS - TAPER RECTANGLE----|

|----RELIGHTS - SEMI-FLUSH-----|

LP11099

- 3x75-Watt Type A
- Hardwire
- UL/CUL Approved

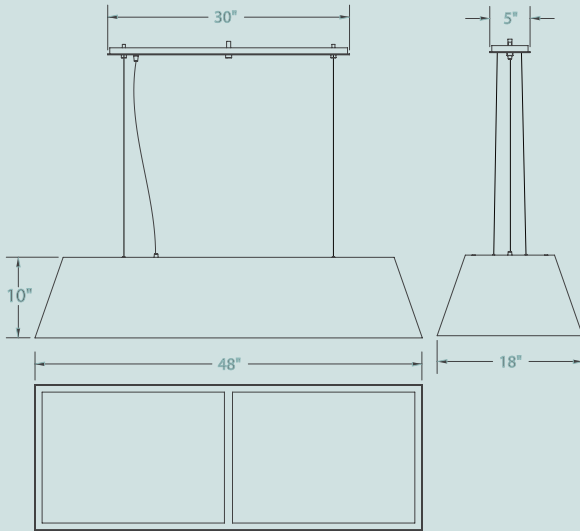

LR11104

- Attaches to Recessed Lighting
- White Acrylic Diffuser/White Finial
- Spring Hooks or Twist/Lock

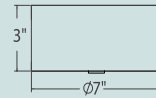

LR11105

- Attaches to Recessed Lighting
- White Acrylic Diffuser/White Finial
- Spring Hooks or Twist/Lock

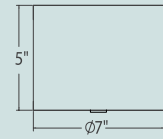

Available Fabric: 305, 313, 317, 328, 614, 690, 692, 749, 758.
See finishing touches on pages 25-26.

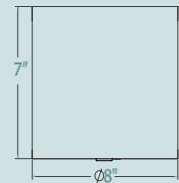
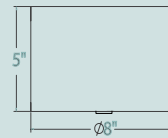
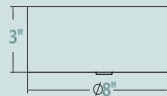
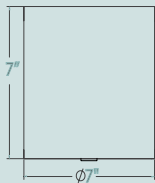

LR11106

- Attaches to Recessed Lighting
- White Acrylic Diffuser/White Finial
- Spring Hooks or Twist/Lock

LR11107

- Attaches to Recessed Lighting
- White Acrylic Diffuser/White Finial
- Spring Hooks or Twist/Lock

LR11108

- Attaches to Recessed Lighting
- White Acrylic Diffuser/White Finial
- Spring Hooks or Twist/Lock

LR11109

- Attaches to Recessed Lighting
- White Acrylic Diffuser/White Finial
- Spring Hooks or Twist/Lock

|----RELIGHTS - SEMI-FLUSH-----|

NEW ADDITIONS TO THE

MESA COLLECTION

Architecturally-influenced
with interesting geometric
metal accents.



LP11120 - shown in 057 Hand-Rubbed Bronze and 313 Taupe Raw Silk.

THE MESA COLLECTION ADDITIONS

-----PENDANTS-----

LP11119

- 2x75-Watt Type A
- Hardwire
- UL/CUL Approved

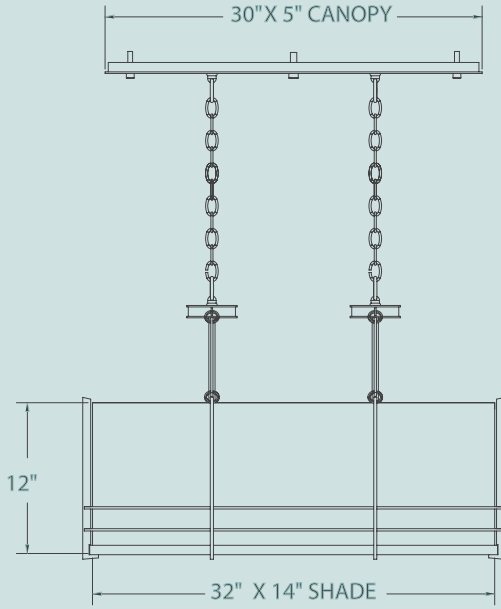

LP11120

- 2x50-Watt Type A
- Hardwire
- UL/CUL Approved

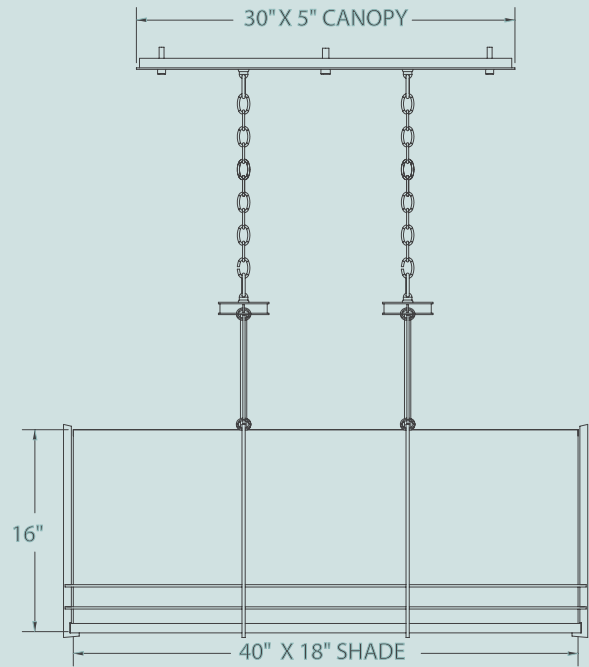















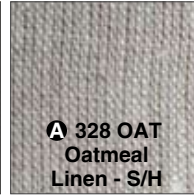



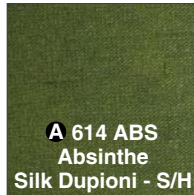
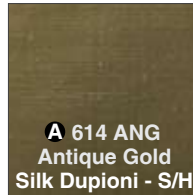

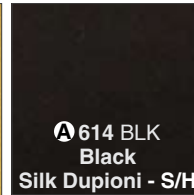

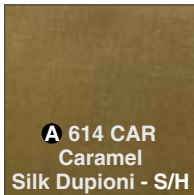
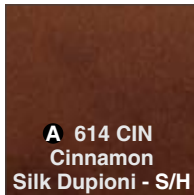
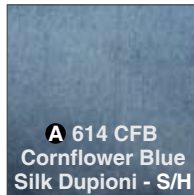
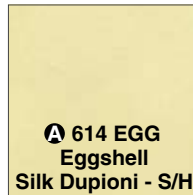
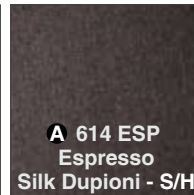

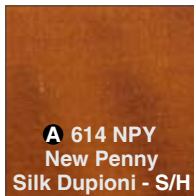
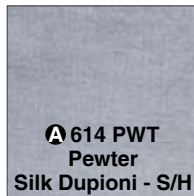

Available Finish: 055, 057.
 Available Fabric: 313, 317, 614.
 See finishing touches on pages 25-26.

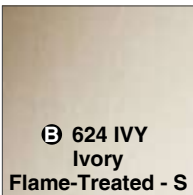
FINISHING TOUCHES

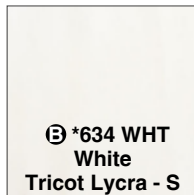
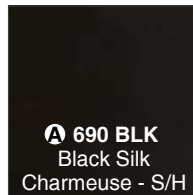
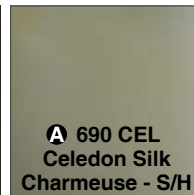
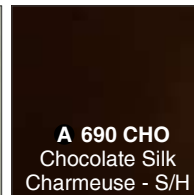
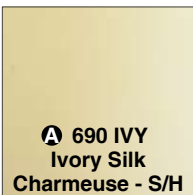
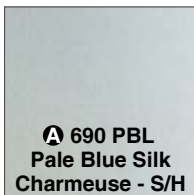
Not all fabrics and finishes are available for all collections.
S/H- Softback and Hardback; S - Softback Only. *Collection Specific.

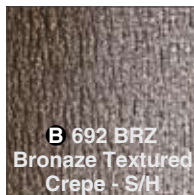
Ⓐ Option A Fabric Ⓑ Option B Fabric

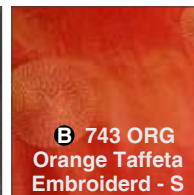
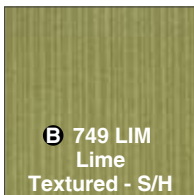
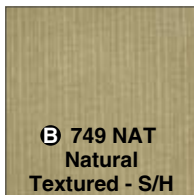
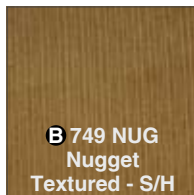
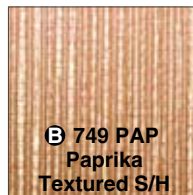
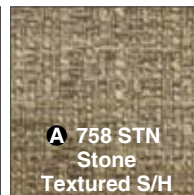
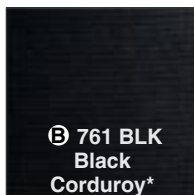
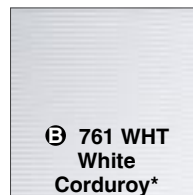
fabrics

 Ⓑ 313 NAT Natural Raw Silk - S/H	 Ⓑ 313 TAU Taupe Raw Silk - S/H	 Ⓑ 317 EGG Eggshell Silk Pongee - S/H	 Ⓑ 317 NAT Natural Silk Pongee - S/H	 Ⓐ 328 BGE Beige Linen - S/H	 Ⓐ 328 OAT Oatmeal Linen - S/H	 Ⓐ 328WHT White Linen - S/H
 Ⓑ 378 BLK Black Silk Chiffon*	 Ⓑ 378 GRY Gray Silk Chiffon*	 Ⓑ 378 WHT White Silk Chiffon*	 Ⓐ 614 ABS Absinthe Silk Dupioni - S/H	 Ⓐ 614 ANG Antique Gold Silk Dupioni - S/H	 Ⓐ 614 AZG Aztec Gold Silk Dupioni - S/H	 Ⓐ 614 BLK Black Silk Dupioni - S/H
 Ⓐ 614 BTC Buttercup Silk Dupioni - S/H	 Ⓐ 614 CAR Caramel Silk Dupioni - S/H	 Ⓐ 614 CIN Cinnamon Silk Dupioni - S/H	 Ⓐ 614 CFB Cornflower Blue Silk Dupioni - S/H	 Ⓐ 614 EGG Eggshell Silk Dupioni - S/H	 Ⓐ 614 ESP Espresso Silk Dupioni - S/H	 Ⓐ 614 IVY Ivory Silk Dupioni - S/H
 Ⓐ 614 MBU Midnight Blue Silk Dupioni - S/H	 Ⓐ 614 MOC Mocha Silk Dupioni - S/H	 Ⓐ 614 NPY New Penny Silk Dupioni - S/H	 Ⓐ 614 PWT Pewter Silk Dupioni - S/H	 Ⓐ 614 POY Poinsettia Silk Dupioni - S/H	 Ⓐ 614 SGP Sugar Plum Silk Dupioni - S/H	 Ⓐ 614 WHT White Silk Dupioni - S/H
 Ⓑ 624 IVY Ivory Flame-Treated - S	 Ⓑ 624 WHT White Flame-Treated - S	 Ⓑ *634 SLV Silver Tricot Lycra - S	 Ⓑ *634 WHT White Tricot Lycra - S	 Ⓐ 690 BLK Black Silk Charmeuse - S/H	 Ⓐ 690 CEL Celedon Silk Charmeuse - S/H	 Ⓐ 690 CHO Chocolate Silk Charmeuse - S/H
 Ⓐ 690 IVY Ivory Silk Charmeuse - S/H	 Ⓐ 690 PBL Pale Blue Silk Charmeuse - S/H	 Ⓐ 690 WHT White Silk Charmeuse - S/H	 Ⓑ 692 BRZ Bronaze Textured Crepe - S/H	 Ⓑ 736 WHT White China Silk - S	 Ⓑ 743 CHO Chocolate Taffeta Embroider - S	 Ⓑ 743 ORG Orange Taffeta Embroider - S
 Ⓑ 749 LIM Lime Textured - S/H	 Ⓑ 749 NAT Natural Textured - S/H	 Ⓑ 749 NUG Nugget Textured - S/H	 Ⓑ 749 PAP Paprika Textured S/H	 Ⓐ 758 STN Stone Textured S/H		
 Ⓑ 761 BLK Black Corduroy*	 Ⓑ 761 WHT White Corduroy*	 Ⓑ 827 JAV Java Embroidered - S	 Ⓑ 828 SEA Seashell Embroidered - S			

FINISHING TOUCHES

Not all fabrics and finishes are available for all collections.
*Collection Specific.

finishes

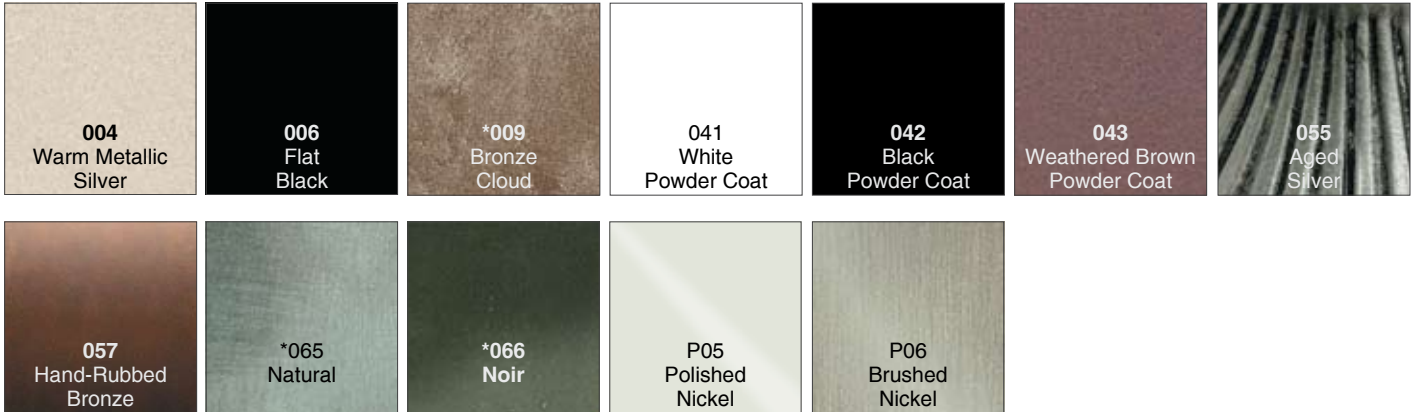

woods



*Please verify all fabrics and finishes,
with customer service, prior to placing an order.*

LIGHT ENHANCING LIFE™